

# IRes your Internet Partner

click to continue >>

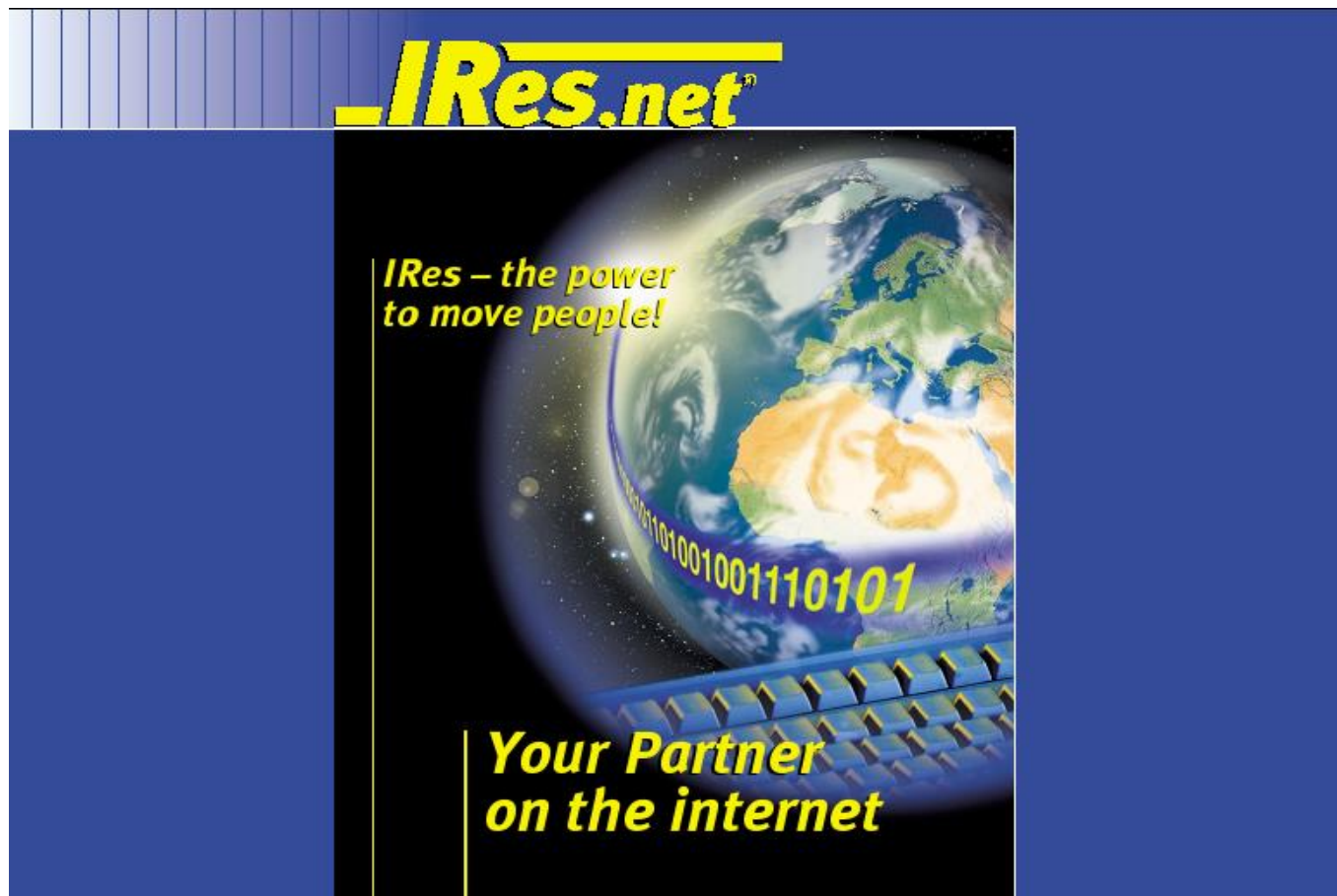

***IRes.net***

*IRes – the power  
to move people!*

*Your Partner  
on the internet*

The graphic features a central image of the Earth from space, with a glowing blue and yellow binary code (01001001001110101) curving around the bottom of the globe. Below the globe, a portion of a computer keyboard is visible. The entire graphic is set against a dark blue background with a lighter blue vertical bar on the left side.



# IRes - Partner

- Very flexible Internet Booking Engine IBE
- Modular Setup
- Corporate ID
- Look and Feel
- Individuell calculation
- Individuell design, text, fonts, color
- Web interface via IRes – Pool admin



# IRes Sabre Consulting

- Sabre specialist
- Many years of Sabre experience
- Hundreds of Travel Agencies working with
- EasyRes based on Sabre
- EasyRes is modular and flexible
- IRes starts where Sabre ends
- Individuell tools and programming



# IRes Travelagency Distribution

- EasyRes for Travelagencies
- EasyRes for Travel Plattforms
- EasyRes for inividuell Appliations



# Internet adons

- EasyRes Internet booking engine
- Easy to install
- Easy to work with
- Easy is fast
- EasyRes Templets
- Easy Calculation
- Easy Languages and Currencies
- Easy Intranet IResagent IRescounter
- Easy Extranet – Webapplikations
- Easy Jump and many other features



# *The Company IRes*

- The Company Technology
- This technology will open up new business vistas for you.
- IRes has benefited from the years of industry experience of Mr. Guenther Insam, company founder and CEO.
- After decades of running a successful travel business, Mr. Insam founded IRes (Internet Reservation Systems) and guided a team of technology and travel specialists through the development of the EasyRes Internet Booking Engine.
- The fruit of their efforts is an extremely powerful and flexible tool for booking airline reservations online, that is as suited to global travel distribution as it is to company-wide intranet systems.



# *The Philosophy*

- As a technology partner to travel providers, we support you in all areas related to e-commerce and online marketing. We offer innovative technology and proven concepts.
- By building on your established business reputation and effectively deploying new technologies for product distribution and communications, your agency can carve out a profitable share of the steadily growing internet commerce.
- Our task is to create a seamless connection between the personalized service you provide to your customers and the constantly evolving expectations of the consumer in the online marketplace. Break new ground today!



# *Main features of the core booking engine*

- EasyRes Internet Booking Engine ( IBE )
- IBE Multilingual Multicurrency
- Consolidators with interesting IRes special sales conditions
- Templates for CI
- Text Module individual and language
- Midoffice System
- Newsletter per Customer CRM
- Administration System IRes-Pool – Agency
- Webinterface Admin
- IKS Calculation Program ( Iata -0 Commison )

# *Main features of the core booking engine*

- Statistics
- A backup database records all bookings made
- Web interfaces for a very comfortable Calculation, Lookout and Feel,
- Web interface for Text/ Button/ Email fields modification
- Jump System ( Deep Link Creator )
- Hot Offer System
- Versions and features : EasyRes
  - Extranet Homepages in look and feel of the Customer ( CI )
  - IResAgent reservations platform for Consolidators fixed calculation
- Booking goes directly to the Consolidator
- IRES Counter Counter version, own Calculation, mixing consolidators and
  - IATA / Soon Charter / No-frills – Best Price analyse
- IResmail Mail newsletter inclusive IBE of selected airlines and prices
- IRes Banner IBE Banner including short query IBE
- IRes Prompter IBE for Callcenter
- IRes Query Boxes



# *Main features of the core booking engine*

- The Modular architecture of the flight booking system follows the same basic principles as our hardware setup.
- As easily as we can increase the capacity of our hardware global components the modular structure of our application allows us to easily add any necessary features or modules without having to redesign a new system.
- The flight engine merges and books “Consolidator Net Fares”, negotiated and published IATA fares inventory online in a seamless process.
- IRes has achieved what the market has long been seeking.

# *Dynamic relational modules*

- Inventory and Database Administration
- Cost and price definition and management
- Currency Administration
- Multiple Language Administration
- Geographic Database
- Translation Module
- Geographic Definition Management
- Commission Parameters Management
- Dynamic Tax Parameters Administration
- General System Parameters control
- Multiple branch and Offices Management
- Affiliate and Profile Management
- User access administration and security parameter settings
- Dynamic Terminal addresses administration and scans optimization



- *Availability Caching System*

- All responses are saved into a cache for subsequent access and given a “life time” defined by diverse criteria such as amount of seats or season.
- The caching system significantly reduces the number of scans generated on the GDS or proprietary host systems and minimizes associated transaction costs by eliminating unnecessary availability requests.



# *Office ID/TA Terminal Address Management*

- IRes.Net connects directly to Sabre by passing any third party connectivity.
- The simultaneous sequential communication with the GDS is channelled via multi-threading TA access.
- IRes.Net designed its own TA and office ID management and can simultaneously address thousands of Terminal addresses in different physical locations through different GDS. Access and interaction parameters are based on the travel company's own defined parameters with the GDS.
- The system automatically assigns the Task or office ID according to a given customer location fully respecting the point of sale and global indicators. Fare requests and availability queries are always generated from the point of sale of the customer.
- Security All transactions and personal informations are highly secured via industry standard SSL (Secure socket layer) protocol that provides full data encryption, server authentication and message integrity.



# *Security*

- All transactions and personal informations are highly secured via industry standard SSL (Secure socket layer) protocol that provides full data encryption, server authentication and message integrity.



# *Product Line*

- The IRes.Net product line comprises different applications based on a common, flexible and interactive architectural platform that provides highly efficient internet reservation capacity allowing wholesalers and suppliers to successfully distribute their inventory through the internet.
- IRes.Net offers specifically engineered and custom-tailored solutions for travel content distributors for B2C, B2B or intranet designed to accurately sell travel content over the internet.



# *EasyRes*

## *Front end B2C engine for direct retail*

- IRes.Net EasyRes is a powerful full-featured, fully customized Internet booking engine (IBE) that enables consumers to directly book their flights arrangements via the Internet with only a few clicks.
- IRes.Net EasyRes also empowers travel agencies or travel portals to actively sell consolidator Net fares, negotiated and published IATA fares inventory online with their own mark-up or earn corresponding provisions.
- EasyRes can also be used for retail directly by inventory suppliers. Consolidators can use EasyRes to directly sell their inventory to consumers from their own web site and therefore extend their distribution channels.

## ■ The EasyRes based on Sabre

Power-shopper functionality for automatic search.

This tool activates itself automatically whenever the requested flight is not available. The customer can define a flexible date range for its departure or return date and the Power-shopper will then automatically search for availabilities with all airlines. Every Individual city pair availability launches automated parallel mechanism.

- Accessing consolidator's net fares databases and validating every single applicable routing regulation governing every single fare within seconds.
  - Query GDS for IATA fares and contracted negotiated fares.
  - Merging of all fares - Simultaneous querying and evaluation of availabilities through GDS for all different fares.
  
- All availability queries to airlines are sent simultaneously allowing a response time for all airlines equivalent to one single query.
  - listing of all available fares in one screen- This total process occurs within seconds allowing consumers to easily complete their booking process within 3 clicks and a few minutes.
  - The last click will send the final passenger data to the GDS and generate a record locator confirming an error free reservation.
  
- Entering of passenger data
- Generation of record locator
- Queuing to adequate PCC or office ID



# *EasyRes*

- The booking engine is fully multilingual and multicurrency
- Layout customization enables web designer, without their extensive knowledge or manipulation of the underlying business logic. HTML, DHTML, WML located in JSP files support customization of the site, including multiple languages and multiple views.
- Background design Logo integration
- Text merge
- Style sheet (CSS) integration  
choice of several Buttons or design and integration of own buttons
- Language module:  
many languages are now available and more can easily be added: all languages are editable to individual wording and phraseology



# *Languages*

- All Languages individual possible to edit through our Text - Language – Module
- Each Customer can create online via Web interface his own IBE look and feel and text and buttons

# *Agency administration parameters and business reporting*

- IRes.Net EasyRes provides retailers with all necessary tools to measure site efficiency and productivity. It records and logs all activities generated through their booking engine, providing detailed valuable informations about all created bookings:
- Real time booking summaries and statistics
- Creation date statistics
- Destinations and departure airports statistics
- Commission and price Calculation adjustments
- Real time and prospective sales reports
- Credit card acceptance and validation possibility
- Determination of the travel cancellation insurance amount
- Full overview of all generated Flight bookings (listing per month)
- Booking details with complete history of booking process
- Form of payment definition
- E-mail and fax confirmation
- Record locator revisit through GDS
- Creation and storage of passenger itinerary

# *B2B / Inventory suppliers (consolidators / Portals)*

- EasyRes fully integrates consolidator net fares with published IATA and contracted negotiated fares loaded in the GDSs and considerably enhances their own inventory and retail power through the internet.
- EasyRes is a cost-effective, customized travel system solutions for consolidators and portals and helps increasing segment production with the minimum of scans.
- Agencies usually do not have their own net fares database and can not afford to have their own IBE.
- The consolidator IBE gives agencies the possibility to resell on line with their own markup. EasyRes empowers agencies to fully use the sell potential offered by the internet.
- Consolidator can multiply their internet retail structure, expand their customer and maximize their revenue. Consolidator can distribute their inventory through the travel agency network and develop strong commercial relation with travel agencies as well as e-commerce sites and travel portals.



# *Additional Features*

- Unlimited storefronts multiplication possibility
- Segments ownership to the consolidator (or agency if requested)
- Customer binding
- Extend retail net
- Individual markup for agencies and affiliates accounts
- Full individual customization of their sites
- Individual editing of wording and language
- Own administration tool and statistics
- Individual fare viewership definition
- Individual agency log-in and recognition
- Individual agency scan vs bookings reporting

# *IRes.Net IATA*<sup>TM</sup>

- IRes.Net Direct basically offers most of the features of the EasyRes engine with consolidated net fares.
- It is the ideal tool that enables an agency to instantly be able to sell official IATA published fares via the internet.
- Negotiated fares loaded in the GDS for a specific PCC or office ID can also be booked through IRes.Net Air Direct.
- The tool is also multilingual and multicurrency and can be fully customized to the look and feel of the agency.
- Worldwide available flight engine for local IATA fares only including Nego and SNAP fares if loaded on the PCC or office ID. (Global indicator and point of sale compatibility)
- All availabilities and fare quote queries and pricing process are GDS-based. Bookings can be channeled automatically to a predefined PCC or office id. One of the main advantage of IRes.Net Air Direct is its extremely short implementation time frame.
- IRes.Net Air Direct can be implemented within a day enabling immediate e-commerce presence.
- Since the IRes.Net technology is modular, net fares can easily be integrated at a later point in the IRes.Net Direct module.

# EasyRes Express

## Versions Query Box examples

- We give an API description
- So everybody can define his own IBE BOX Intro
- Mini Box
- each customer can use his own ready made Box
- or can modify it ( colour, template, size, language )

Linienflug suchen und direkt online buchen			
<b>Abflugort</b>	<input type="text"/>	<b>Reiseziel</b>	<input type="text"/>
<b>Abflugdatum</b>	1 <input type="button" value="v"/> Januar <input type="button" value="v"/>  Kalender	<b>Rückflugdatum</b>	1 <input type="button" value="v"/> Januar <input type="button" value="v"/>  Kalender
	Exaktes Datum <input type="button" value="v"/>		Exaktes Datum <input type="button" value="v"/>
<b>Abflugzeit</b>	Beliebig oder... <input type="button" value="v"/>	<b>Rückflugzeit</b>	Beliebig oder... <input type="button" value="v"/>
		<b>oder</b>	<input type="checkbox"/> Kein Rückflug
<b>Reisende</b>		<b>Zusätzliche Optionen</b>	
Erwachsene	1 (ab 12 Jahren) <input type="button" value="v"/>	Klasse	Economy <input type="button" value="v"/>
Kinder	0 <input type="button" value="v"/>	Airline	Beliebig oder... <input type="button" value="v"/>
Kleinkinder	0 <input type="button" value="v"/>		<input type="button" value="Suche starten"/>

# Express Box

 **Express-Flugabfrage**

Von:

Nach:

Abflugdatum:

Rückflugdatum:

Reisende:

**Jetzt suchen**

# Design 1

Hin- und Rückflug  Nur Hinflug

**Flugstrecke**

Von   
z.B. München oder Kürzel MUC

Nach

Nur Direktflüge (ohne Umsteigen, Zwischenstopps möglich)

**Reisedaten**

Hinflug:

Rückflug:

**Reisende**

Geben Sie hier Anzahl und Art der Reisenden an.  
Sie können für max. 9 Reisende buchen.

Erwachsene

Kinder (2-11 Jahre)

Kleinkinder (unter 2 Jahre)

**Weitere Optionen**

Klasse

Bestimmte Fluggesellschaft

# Design 2

<b>HINFLUG</b>	
von	<input type="text"/>
nach	<input type="text"/>
Reisebeginn	<input type="text" value="1"/> <input type="text" value="Januar"/>
	<input type="text" value="Nur dieser Hinflugtag"/>
	Kein Rückflug <input type="checkbox"/>
Uhrzeit	<input type="text"/>
<b>RÜCKFLUG</b>	
Rückflug	<input type="text" value="1"/> <input type="text" value="Januar"/>
	<input type="text" value="Nur dieser Rückflugtag"/>
Uhrzeit	<input type="text"/>
<b>ANZAHL PERSONEN</b>	
Erwachsene	<input type="text" value="1"/>
Kinder (2 - 11 J.)	<input type="text" value="0"/>
Babies (unter 2 J.)	<input type="text" value="0"/>
<b>ZUSÄTZLICHE OPTIONEN</b>	
Klasse	<input type="text" value="Economy"/>
Bevorzugte Airline	<input type="text"/>
<input type="button" value="Suche starten"/>	

# Design 3

Flugsuche

Hin- und Rückflug  Hinflug

Von

Nach

Hinflug

Rückflug

Nur Direktflüge

Klasse

Fluggesellschaft

Erwachsene

Kinder

Babys

# Design 4

**Flugsuche**

Von:

Nach:

Abflug: Januar

Art der Reise:  Einfacher Flug  
 Hin- und Rückreise mit diesem Rückflugdatum

Rückflug: Januar

Serviceklasse: Economy

Airline:

Bitte wählen Sie den entsprechenden Passagiertyp für sich und alle begleitenden Passagiere.

Erwachsene:

Kinder 2:

Kleinkinder 3:

Flugsuche starten

# Design 5

Flug:	Von	<input type="text"/>
	Nach	<input type="text"/>
	Datum	1 <input type="text"/> Januar <input type="text"/>
	Abflugzeit	beliebig <input type="text"/>
		<input checked="" type="radio"/> Hin- und Rückflug <input type="radio"/> One Way
Rückflug:	Datum	1 <input type="text"/> Januar <input type="text"/>
	Abflugzeit	beliebig <input type="text"/>
Personen:	Erwachsene*	1 <input type="text"/>
	Kinder (2-11 J.)	----- keine ----- <input type="text"/>
	Babies (unter 2 J.)	----- keine ----- <input type="text"/>
Klasse:		Economy <input type="text"/>
bevorzugte Airline:		<input type="text"/>
<input type="button" value="Flugsuche starten"/>		

# *IRes Agent*

## ***Consolidator Platform single and multiple Consolidators***

- The IRes.Net Agent provides agencies with the web-based application they need to ensure maximum value for their distribution budget. Inventory suppliers as well as travel agencies are pressured by the market to optimize agent productivity and maximize profitability.
- Agents need a system that can simultaneously search and analyze vast array of fares inventory and their availability for a given request.
- IRes.Net Agent not only displays a comprehensive list of rule-verified applicable fares but effectively retrieve their availability within seconds, allowing agents to streamline, improve work flow and increase productivity. Agents that access the consolidator intranet are able to see and book their contracted fares through the consolidator database.
- IRes.Net Agent handles complex restrictions that can govern a single net or commission- based fare without errors and is customized to the travel agency business agreement with its consolidator. The system actually is able to validate over 350 fields of rule sets. The inventory supplier can define selective viewership of fares and individual net price markup per agency.



# *Agencies Intranet for consolidator*

- Control costs and maximize revenue!
- We know that in today's competitive travel market, it is vital to manage costs and maximize the value you receive from suppliers.

# Features

- Single Airline selection possible
- Live display of GDS-availability for direct comparison
- Net price display can be enabled or disabled Net and retail price shown parallel if desired
- Automatic agency recognition
- Power-shopper functionality per airline or all airlines
- Enhanced Parallel availability retrieval
- Automised PNR placement on pre-defined PCC or office ID
- Enhanced statistics for inventory suppliers
- Scan and booking ratio per agency or branch
- Destinations statistics per carrier and global
- Statistics booking date vs departure date
- Optimized Scan reduction and management through permanent caching mechanisms

# IResAgent Example

The screenshot shows a Microsoft Internet Explorer browser window displaying the IResAgent website. The browser title is "IRes-Agent Ihr Online Partner - Microsoft Internet Explorer - Everyday.com". The address bar shows "http://www.iresagent.de/index.html". The website header features the "IRes.net" logo and the text "INTERNET RESERVATION SYSTEMS".

The main search area is titled "ERWEITERTE SUCHE" and includes the following fields and options:

- von:** [Empty]
- nach:** [Empty]
- Datum hin:** 22 AUG
- Datum zurück:** 05 SEP
- Airlines:** [Empty]
- Klasse / Reisende (Erw, Kinder, Kleinkinder):** Economy / 1 Erw 0 Kind 0 Kleinkind
- Tarif:** Sonder
- Modus:** Preis
- Consolidator:** AERTICKET AG (dropdown menu is open)

The dropdown menu for "Consolidator" lists the following options:

- AERTICKET AG
- AerTicket Nuernberg
- Condor Schweiz
- DER Tour
- FTI.at
- Mc Flight
- Sparflug
- TLR Tiroler Landes Reisebüro

Below the dropdown menu, the search criteria are displayed:

- Ab:** Deutschland
- Nach:** Vereinigte Staaten von Amerika
- Vom:** 22 August
- bis zum:** 05 September
- Fluggesellschaft:** Beliebige Fluggesellschaft oder...
- Reisende:** 1 Erwachsene 0 Kinder 0 Kleinkinder
- Klasse:** Economy
- Tarif:** Sonder
- Modus:** Preis
- Consolidator:** AERTICKET AG

A "Flugsuche starten" button is visible at the bottom right of the search area. The Windows taskbar at the bottom shows the Start button, several open applications (Internet Explorer, Microsoft Word, Microsoft Office), and the system tray with the date "08.08.2004" and time "09:22 Sonntag".

# *Advantages*

- Increase productivity and reduce costs of Inventory
- Supplier-controlled segment ownership with Full PNR access
- Increase GDS-segment compensation
- Enlarge distribution platform
- Ability to define fare viewership
- Ability to define price level individually for every single agency
- Monitor look to book ratio of agency Travel Agency
- Sequential availability search that enables agents to process queries within seconds and to close more sales in less time with less efforts and no mistakes
- Increase agent productivity
- Increase agent close ratio Handle more calls and customers Rule-verified reservation
- Eliminate debit memos
- Easy-to-use intuitive graphical interface requiring no training
- Reduce call time and communication costs
- Increase sales and commissions

# IResAgent Fare display

von		nach		Datum hin		Datum zurück		Airlines		Klasse / Reisende (Erw, Kinder, Kleinkinder)			Tarif		Modus		Suche
muc		lon		23 JAN		06 FEB				Economy / 1 Erw 0 Kind 0 Kleink			Alle		Preis		
Sel.	Typ	Fluggesellschaft		Abflughafen		Zielflughafen		Tarif zzgl. Gebühren		Minimale Reisedauer		Maximale Reisedauer		Bestimmungen			
<input type="checkbox"/>	N	Lufthansa (LH)		München (MUC)		London (LON)		53.00 EUR		0 Tage		180 Tage		<a href="#">TKOMBI2</a>			
<input type="checkbox"/>	N	Lufthansa (LH)		Augsburg (AGB)		London (LON)		53.00 EUR		0 Tage		180 Tage		<a href="#">TKOMBI2</a>			
<input type="checkbox"/>	N	British Midland (BD)		Augsburg (AGB)		London (LON)		53.00 EUR		0 Tage		180 Tage		<a href="#">TKOMBI2</a>			
<input type="checkbox"/>	N	British Midland (BD)		München (MUC)		London (LON)		53.00 EUR		0 Tage		180 Tage		<a href="#">TKOMBI2</a>			
<input type="checkbox"/>	N	Cirrus (C9)		Augsburg (AGB)		London (LON)		54.00 EUR		0 Tage		180 Tage		<a href="#">TCOMC9</a>			
<input type="checkbox"/>	N	Cirrus (C9)		München (MUC)		London (LON)		54.00 EUR		0 Tage		180 Tage		<a href="#">TCOMC9</a>			
<input type="checkbox"/>	N	British Midland (BD)		München (MUC)		London (LON)		59.00 EUR		SU		14 Tage		<a href="#">WINTER1</a>			
<input type="checkbox"/>	N	Lufthansa (LH)		München (MUC)		London (LON)		59.00 EUR		SU		14 Tage		<a href="#">WINTER1</a>			
<input type="checkbox"/>	N	Lufthansa (LH)		Augsburg (AGB)		London (LON)		59.00 EUR		SU		14 Tage		<a href="#">WINTER1</a>			
<input type="checkbox"/>	N	British Midland (BD)		Augsburg (AGB)		London (LON)		59.00 EUR		SU		14 Tage		<a href="#">WINTER1</a>			
<input type="checkbox"/>	N	British Airways (BA)		Augsburg (AGB)		London (LON)		80.00 EUR		-		-		<a href="#">NEUNBAO</a>			
<input type="checkbox"/>	N	British Airways (BA)		München (MUC)		London (LON)		80.00 EUR		-		-		<a href="#">NEUNBAO</a>			
<input type="checkbox"/>	S ECO	British Airways (BA)		München (MUC)		London - Heathrow (LHR)		80.00 EUR		0 Tage		365 Tage		<a href="#">Klick</a>			
<input type="checkbox"/>	S ECO	British Airways (BA)		München (MUC)		London, Gatwick (LGW)		80.00 EUR		0 Tage		365 Tage		<a href="#">Klick</a>			
<input type="checkbox"/>	N	Air France (AF)		Augsburg (AGB)		London (LON)		92.00 EUR		SU		14 Tage		<a href="#">NPRDE</a>			



# *Email Booking Confirmation Delivery*

- EasyRes is sending different Email to
- The customer
- Travel agency
- Consolidator

# Customer Email

## Agency

Agency

Street address or postbox

ZIP - City

Email Address

Phone

Fax

Sabre Demo (1227)

Rottmannstraße 11

80333 München

insam@ires.net

01805 54916516

01805 358432

## Reservation status:

- Your reservation has been successfully concluded. Your record locator is:  
**2VMDB5**
- Please print this page now, if you have a printer attached, to serve as a confirmation.

## Cost of flight(s):

<u>type</u>	<u>Price per person</u>	<u>Taxes per Person</u>	<u>number</u>	<u>Total</u>
adult	515.00 EUR	131.00 EUR	1	646.00 EUR
supplement for E-ticket			1	0.00 EUR
<b>Total:</b>				<b>646.00 EUR</b>

# Customer Email

## Flight information:

Type	<u>Flight</u>	<u>Departure</u>	<u>Arrival</u>
	AF 1123 (Air France) Boeing 737-500	Munich, DE (MUC) on Sunday, the 29 Aug 2004 07:10	Paris, Charles de Gaulle, FR (CDG) on Sunday, the 29 Aug 2004 08:55
	AF 8994 (Air France) Boeing 767-300 Passenger	Paris, Charles de Gaulle, FR (CDG) on Sunday, the 29 Aug 2004 10:35	New York - J. F. Kennedy Airport - NY, US (JFK) on Sunday, the 29 Aug 2004 12:55
	AF 5 (Air France) <u>Airbus Industrie A340-300</u>	Newark - NY, US (EWR) on Sunday, the 12 Sep 2004 17:10	Paris, Charles de Gaulle, FR (CDG) on Monday, the 13 Sep 2004 06:15
	AF 1422 (Air France) Boeing 737-500	Paris, Charles de Gaulle, FR (CDG) on Monday, the 13 Sep 2004 07:00	Munich, DE (MUC) on Monday, the 13 Sep 2004 08:35

## Passengers

<u>Title</u>	<u>First Name</u>	<u>Last Name</u>	<u>Birthday</u>	<u>ISIC No.</u>
Mr.	guenther	insam		



# Customer Email

## Additional remarks:

FareBase: AERNET/26991/3/32/AFM/YM[S]DELC/FaID=240545

Validity: This fare is only valid for departures between the 07/01/2004 and the 08/31/2004 !!

Minstay/MaxStay: SU-60: Sunday rule (the trip time must include at least one Sunday) - The travel duration may not to exceed 60 days.

Farebasis: **Normal fare**, for persons this an age of 12 years or older. Passengers between the ages of 2 and 11 are considered to be children. Passengers up to 23 month are considered to be infants.



## Attention:

- To verify payment, ticket issuance or delivery details with us, please contact us within 3 days of reservation. Our office hours are from Monday to Friday 09:00 AM - 06:00 PM.
- If we have notified you of a ticket deadline within 3 days of today, please i m m e d i a t e l y contact us at Tel.: 01805 54916516.
- Please note that this reservation will be cancelled without an alternative if you do not hold yourself to this deadline. After that period you have no legal right to the reservation under the previously confirmed prices and conditions.
- A reservation only becomes legally binding after examination of the fare rules and completion of contract by written confirmation from the travel vendor or his agent.

# Profi Email Travel Agency Info

⌂

## Internet Reservation

Please check the rules and regulations now! PLEASE BE AWARE THAT IF ABC TRAVEL SERVICE RECIEVES A CREDIT CARD PAYMENT BY YOU, WE WILL ISSUE YOUR TICKETS IMMEDIATELY !!!! WITHOUT CREDITCARD INFO IN YOUR BOOKING, WE WILL GIVE YOU 3 DAYS TO CONTACT US AT +49 621 72 92 0 or [internet@abctravel.de](mailto:internet@abctravel.de) TO CONFIRM AND PAY. IF NOT YOUR RESERVATION WILL BE AUTOMATICALLY CANCELLED !!!!!

**issue physical tickets**

Fax: +496217292555

**place tickets for airport pickup**

Fax: +496217292555

**cancellation**

Fax: +496217292555

□

## Agency

**Agency ABC TRAVEL SERVICE**

ABC Travel Service USA (998)

**Street address or postbox**

Gorexheimerstr. 4

**ZIP - City**

68309 Mannheim

**Email Address [internet@abctravel.de](mailto:internet@abctravel.de)**

[internet@abctravel.de](mailto:internet@abctravel.de)

**Phone +49 621 72 92 0**

0621 / 72920

**Fax +49 621 72 92 555**

0621 / 7292555

## **Reservation status:**

- Your reservation has been successfully concluded. Your record locator is:  
**2U22IE**
- Please print this page now, if you have a printer attached, to serve as a confirmation.

# Profi Email Itinerary CRS

## Request to the reservation system:

```
[BOOKING] /CONFIG=Sabre /CHANGEPC=5CS /AUTOCLOSE=TRUE
[SHORTSELL]
02 01 NW      8324 FRA AMS 1105 1220 21SEP 21SEP 1234567   MM 0 F70 D 00
XXXXXXXXXX 000000000.00      0000 P XXXXXXXXXXXXXXX V7 /CLASS=V /SEATS=1
/SELL=NORMAL
02 02 NW      47 AMS DTW 1635 1915 21SEP 21SEP 1234567   DD 0 333 D 00
XXXXXXXXXX 000000000.00      0000 P XXXXXXXXXXXXXXX V7 /CLASS=V /SEATS=1
/SELL=NORMAL
02 03 NW      993 DTW MIA 2108 2355 21SEP 21SEP 1234567       0 319 D 00
XXXXXXXXXX 000000000.00      0000 P XXXXXXXXXXXXXXX V7 /CLASS=V /SEATS=1
/SELL=NORMAL
24 01 NW      986 MIA DTW 1230 1528 02OCT 02OCT 1234567   L 0 D9S D 00
XXXXXXXXXX 000000000.00      0000 P XXXXXXXXXXXXXXX V9 /CLASS=V /SEATS=1
/SELL=NORMAL
24 02 NW      52 DTW FRA 1740 0750 02OCT 03OCT 1234567   DD 0 333 D 00
XXXXXXXXXX 000000000.00      0000 P XXXXXXXXXXXXXXX V9 /CLASS=V /SEATS=1
/SELL=NORMAL
[ROUTING]
/FROM=FRA /TO=MIA /DEPDATE=21SEP
/FROM=MIA /TO=FRA /DEPDATE=02OCT
[NAMES]
/LAST="CAMACHO" /FIRST="LUIS" /TITLE=MR /PTC=ADT /ID=1
[PHONES]
/NR="0621-7292-0" /TYPE=AGENCY
/NR="330-7490" /TYPE=BUSINESS
[INVOICE]
/LAST="DIAZ" /FIRST="MARILYN" /STREET="PSC 5 BOX 228" /CITY="APO AE"
/ZIP="09050"
[AGENCY]
```

# Profi Email Customer Info

The reservation system has responded to your reservation request as follows:

[FILEKEY]2U22IE

3

## Customer Info:

**Title** Mr  
**First Name** marilyn  
**Last Name** diaz  
**Street address or Postbox** psc 5 box 228  
**Zip Code** 09050  
**City** apo ae  
**State or Province** apo ae  
**Country** DE  
**Daytime phone** 330-7490  
**Email:** marilyn.diaz@deca.mil

## Billing address Delivery Address (ATTENTION !! NO APO ADDRESSES)

marilyn diaz	marilyn diaz
psc 5 box 228	psc 5 box 228
09050 apo ae	09050 apo ae
DE	DE

## For your database:

Mr; ; marilyn; diaz; ; ; psc 5 box 228; ; ; 09050 ; apo ae; apo ae; DE;  
330-7490; ; ; marilyn.diaz@deca.mil; Bill; marilyn diaz; psc 5 box 228 ;  
09050 apo ae; DE; ; Delivery; marilyn diaz; psc 5 box 228 ; 09050 apo  
ae; DE;

# Profi Email

## Passengers

<u>Title</u>	<u>First Name</u>	<u>Last Name</u>	<u>Birthday</u>	<u>ISIC No.</u>
Mr.	LUIS	CAMACHO	10/27/1970	



## Flight information:

Type	<u>Flight</u>	<u>Departure</u>	<u>Arrival</u>
	NW 8324 (Northwest Airlines) Fokker 70	Frankfurt, DE (FRA) on Tuesday, the 21 Sep 2004 11:05	Amsterdam, NL (AMS) on Tuesday, the 21 Sep 2004 12:20
	NW 47 (Northwest Airlines) Airbus <u>Industrie</u> A330-300	Amsterdam, NL (AMS) on Tuesday, the 21 Sep 2004 16:35	Detroit Metro - MI, US (DTW) on Tuesday, the 21 Sep 2004 19:15
	NW 993 (Northwest Airlines) Airbus <u>Industrie</u> A319	Detroit Metro - MI, US (DTW) on Tuesday, the 21 Sep 2004 21:08	Miami - FL, US (MIA) on Tuesday, the 21 Sep 2004 23:55
	NW 986 (Northwest Airlines) McDonnell Douglas DC-9- 30/40/50	Miami - FL, US (MIA) on Saturday, the 02 Oct 2004 12:30	Detroit Metro - MI, US (DTW) on Saturday, the 02 Oct 2004 15:28
	NW 52 (Northwest Airlines) Airbus <u>Industrie</u> A330-300	Detroit Metro - MI, US (DTW) on Saturday, the 02 Oct 2004 17:40	Frankfurt, DE (FRA) on Sunday, the 03 Oct 2004 07:50



# Profi Email Rules

## Cost of flight(s):

<u>type</u>	<u>Price per person</u>	<u>Taxes per Person</u>	<u>number</u>	<u>Total</u>
<u>adult</u>	315 USD	166 USD	1	481 USD
<u>supplement for E-ticket</u>			1	5 USD
<b>Total:</b>				<b>486 USD</b>

**Additional remarks: Please make sure to email or fax us your reservationnumber and creditcard info to make sure we recieved it at internet@abctravel.de or +49 621 / 72 92 555.**

**FareBase:** ABCMil/4018/3/38/NW/V/Y/VSPWU20/VSPWU20/FaID=33L

**Validity:** This fare is only valid for departures between the 08/27/2004 and the 10/31/2004 !!

**Minstay/MaxStay:** SU-30: Sunday rule (the trip time must include at least one Sunday) - The travel duration may not to exceed 30 days.

**Farebasis:** With each passenger a maximum of 2 Children and a maximum of 1 Infant may travel. Passengers between the ages of 2 and 11 are considered to be children. Passengers up to 23 month are considered to be infants.

**Outbound days:** Sunday 0 USD / Monday 0 USD / Tuesday 0 USD / Wednesday 0 USD / Thursday 0 USD / Friday 0 USD / Saturday 0 USD

**Inbound days:** Sunday 0 USD / Monday 0 USD / Tuesday 0 USD / Wednesday 0 USD / Thursday 0 USD / Friday 0 USD / Saturday 0 USD

**Discounts (Children / Infants):** Children erhalten 33% Ermäßigung auf den Erwachsenenpreis (Bulk fare). Infants erhalten 90% Ermäßigung auf den Erwachsenenpreis (Bulkfare). The indicated discounts only apply if no other child or infant fares exist in the database.

**Minimum Selling:**

# EasyRes bookings are going into Outlook

The screenshot shows the Microsoft Outlook interface. The left sidebar displays the 'E-Mail' folder structure, including 'Posteingang in Ginsam (512)', 'Posteingang (208)', 'Ungeliesene Nachrichten (208)', 'Zur Nachverfolgung [1]', 'Gesendete Objekte', 'Posteingang in IRES Buchungen (8414)', 'Posteingang in IRES.net (4523)', 'Gelöschte Objekte', and 'Entwürfe [22]'. The main pane shows a list of emails from 'IRES Automator' with columns for 'Von', 'Betreff', 'Erhalten', and 'Größe'. The bottom taskbar shows the Start button and several open applications, including Microsoft Word and Internet Explorer. The system tray indicates the time is 09:46 on Sonntag, 08.08.2004.

Von	Betreff	Erhalten	Größe
IRES Automator	WORLDSPAN/ZU22IE/998/ABC Travel Service USA/08/08/20...	So 08.08.2004 09:02	34 KB
IRES Automator	SABRE/GFWQIF/185/Onlinetravel GmbH/08.08.2004 03:02:3...	So 08.08.2004 03:03	27 KB
IRES Automator	SABRE/JZJKYW/636/Traveljungle travelclub TC/08.08.2004 ...	So 08.08.2004 00:40	41 KB
Datum: Gestern			
IRES Automator	SABRE/IJINGY/925/AndaleMexico Tours SA de CV/08/07/20...	Sa 07.08.2004 20:34	27 KB
IRES Automator	SABRE/GDHMJE/954/Weltentdecker Reisen/07.08.2004 19:5...	Sa 07.08.2004 19:53	24 KB
IRES Automator	SABRE/HRVJNS/926/3157/Touristik-Boerse/07.08.2004 19:5...	Sa 07.08.2004 19:51	45 KB
IRES Automator	SABRE/ETIKIG/147/IhrFlug.de/07.08.2004 19:39:19/Res03	Sa 07.08.2004 19:39	33 KB
IRES Automator	SABRE/HQBOJM/926/Touristik-Boerse/07.08.2004 19:21:00/...	Sa 07.08.2004 19:21	23 KB
IRES Automator	GALILEO/MV41C6/1005/Centrum Biletow Lotniczych/07.08.2...	Sa 07.08.2004 18:53	23 KB
IRES Automator	WORLDSPAN/L95ZWN/955/ABC Travel Service Euro/08/07/2...	Sa 07.08.2004 18:44	39 KB
IRES Automator	SABRE/GPRPJB/926/3157/Touristik-Boerse/07.08.2004 18:2...	Sa 07.08.2004 18:27	45 KB
IRES Automator	SABRE/GCXRIA/926/1118/Touristik-Boerse/07.08.2004 18:1...	Sa 07.08.2004 18:15	57 KB
IRES Automator	SABRE/GWYKTY/212/IATADEStored - TestID/07.08.2004 18:...	Sa 07.08.2004 18:10	28 KB
IRES Automator	SABRE/ERTAIY/212/IATADEStored - TestID/07.08.2004 18:0...	Sa 07.08.2004 18:05	28 KB
IRES Automator	WORLDSPAN/TQ86XD/998/ABC Travel Service USA/08/07/2...	Sa 07.08.2004 17:32	33 KB
IRES Automator	SABRE/CYW5MA/954/Weltentdecker Reisen/07.08.2004 16:...	Sa 07.08.2004 16:51	32 KB
IRES Automator	SABRE/ICLEWS/954/Weltentdecker Reisen/07.08.2004 16:4...	Sa 07.08.2004 16:41	24 KB
IRES Automator	SABRE/CUYWFV/1/Travelclub.de (1) TC/07.08.2004 16:32:08...	Sa 07.08.2004 16:32	29 KB
IRES Automator	SABRE/CUUJON/954/Weltentdecker Reisen/07.08.2004 16:2...	Sa 07.08.2004 16:29	23 KB
IRES Automator	SABRE/DNCJSP/275/Reisebüro Kimm/07.08.2004 15:59:02/R...	Sa 07.08.2004 15:59	24 KB
IRES Automator	WORLDSPAN/4BURHW/955/ABC Travel Service Euro/08/07/...	Sa 07.08.2004 15:27	39 KB
IRES Automator	SABRE/BPYEWG/926/4500002/Touristik-Boerse/07.08.2004 ...	Sa 07.08.2004 14:07	28 KB
IRES Automator	SABRE/IEQCWX/4002/Condor Reisen AG/07.08.2004 13:41:3...	Sa 07.08.2004 13:42	28 KB
IRES Automator	SABRE/IDODVO/1201/Airline Flug Preise AFP/07.08.2004 13:35:51/Re...	Sa 07.08.2004 13:36	29 KB
IRES Automator	SABRE/BOZQNJ/45/Fairtime/07.08.2004 13:19:06/Res05	Sa 07.08.2004 13:19	27 KB
IRES Automator	SABRE/HWSMYC/771/Tai Reisen/07.08.2004 12:45:44/Res02	Sa 07.08.2004 12:46	41 KB

# Administration EasyRes

- Administration Webinterface (german)
- [www.ires.net](http://www.ires.net)
- <https://secure.res.de/agent>
- Entrance:

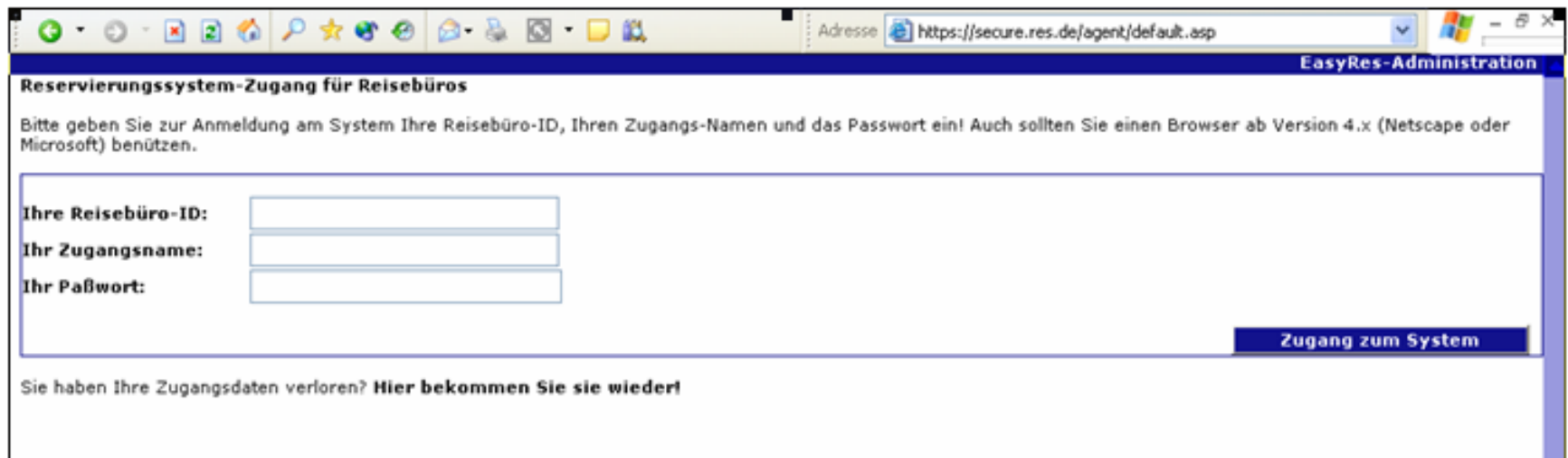

The screenshot shows a web browser window with the address bar containing `https://secure.res.de/agent/default.asp`. The page title is "EasyRes-Administration". The main heading is "Reservierungssystem-Zugang für Reisebüros". Below the heading, there is a message: "Bitte geben Sie zur Anmeldung am System Ihre Reisebüro-ID, Ihren Zugangs-Namen und das Passwort ein! Auch sollten Sie einen Browser ab Version 4.x (Netscape oder Microsoft) benutzen." There are three input fields: "Ihre Reisebüro-ID:", "Ihr Zugangsname:", and "Ihr Paßwort:". A blue button labeled "Zugang zum System" is located at the bottom right of the form area. Below the form, there is a link: "Sie haben Ihre Zugangsdaten verloren? **Hier bekommen Sie sie wieder!**".

# Search for

1. Filekey
2. Name
3. Country Area Code

EasyRes-Administration

Filekey:

Nachname:

Postleitzahl:

Ort:

**Kunden suchen**

Title	Vorname	Nachname	Strasse	PLZ	Ort	Tel. Tags	Email
Herr	guenther	insam	Rottmannstrasse	80333	munich	089549165 11	ginsam@ires.net
Herr	guenther	insam	Rottmannstrasse	80333	munich	089549165 11	ginsam@ires.net
Herr	adam	woodtest	Bath Road	99999	London	00442087459034	adam.wood@worldspan.com
Herr	adam	woodtest	Bath Road	99999	London	00442087459034	adam.wood@worldspan.com
Herr	adam	woodtest	Bath Road	80333	London	00442087459034	adam.wood@worldspan.com
Herr	adam	woodtest	Bath Road	80333	London	00442087459034	adam.wood@worldspan.com
Herr	Adam	Woodtest	242 Bath Road	11111	London	00442087459034	adam.wood@worldspan.com
Herr	Adam	Woodtest	242 Bath Road	11111	London	00442087459034	adam.wood@worldspan.com
Herr	test	test	rottmann	80333	munich	089 12313	insam@ires.net
Herr	test	test	rottmann	80333	munich	089 12313	insam@ires.net
Herr	asdasd	asdasd	asdfasdfasdf	123123	asdasd	089123	insam@ires.net
Herr	asdasd	asdasd	asdfasdfasdf	123123	asdasd	089123	insam@ires.net

**VERWALTUNG**

- Kundendaten Online
- Kundendaten Offline
- Reservierungsübersicht
- Reservierungen

**ADMINISTRATION**

- Statistik
- Neu Anmelden

# Search for:

1. Booking from – to period
  2. Client / Pax
  3. Booking date / Departure date
- >> Direct access to the PNR/ Booking native mode

RESERVIERUNGSÜBERSICHT  
Wählen Sie den von Ihnen gewünschten Kunden oder den gewünschten Buchungszeitraum.

Startdatum der Einträge:

Enddatum der Einträge:

Kunde:

Sortierung:  Buchungsdatum  Abflugdatum

[Abflug-Check](#) [Informationen anzeigen](#)

Buchungsdatum	Abflug	PNR	Kunde Telefon / EMail	Umsatz	Status
08.08.2004	29.08.2004	2VMDB5	MR guenther insam / 089549165 11 / ginsam@ires.net	646.00 EUR	?

Achtung! Dieses Tool unterstützt derzeit nur Buchungen die unter Sabre gebucht wurden!

**EasyRes-Administration**

**VERWALTUNG**

- Kundendaten Online
- Kundendaten Offline
- Reservierungsübersicht
- Reservierungen

**ADMINISTRATION**

- Statistik
- Neu Anmelden

# Search for

PNR Filekey

History / Queue / Stored fare

Ticket issue date

Ticket order to the Consolidator

Remarks, Storno, Queue, Rail and fly

The screenshot shows a web browser window with the address bar containing the URL: <https://secure.res.de/agent/default.asp?SessionID=37292&Key>. The browser title is "EasyRes-Administration".

The main content area is titled "RESERVIERUNGEN VERWALTEN" and includes the instruction: "Wählen Sie den von Ihnen gewünschten Kunden oder den gewünschten Buchungszeitraum." Below this, there is a search form with the following elements:

- PNR:** A text input field followed by a "darstellen" button.
- Infos:** Three buttons: "History", "Queue History", and "Stored Fare".
- Aktionen:** Six buttons: "Ticketing Frist", "Ticket Bestellung", "Remarks", "Storno", "Queue", and "Rail & Fly".

A right-hand sidebar menu is visible, containing the following sections:

- VERWALTUNG**
  - Kundendaten Online
  - Kundendaten Offline
  - Reservierungsübersicht
  - Reservierungen
- ADMINISTRATION**
  - Statistik
  - Neu Anmelden





# IRes Multilingual

- Each Client can have his own disigned frontend – base on our frontend varibales database

# Webpage XL Russian Customer

**INTERNET RESERVATION SYSTEMS**

Рейсы Пожалуйста, выберите ...

Путешествующие	Запрос рейса	Выбор тарифа	Наличие свободных мест	Расписание рейсов	Резервирование	Подтверждение
----------------	--------------	--------------	------------------------	-------------------	----------------	---------------

Язык: Select Language...

Валюта: United States Dollars, United States (USD)

**Сколько человек путешествует?**

Теперь Вы можете составить свой персональный маршрут. Для запроса свободных мест и точных расценок, укажите, пожалуйста, в каждой возрастной ячейке число путешествующих.

Взрослые 1 Дети (2 -11 лет): 0 Маленькие дети (до 2 лет): 0

**Кто путешествует?**

Большинство авиакомпаний предлагает скидки для определенных категорий путешествующих, например, молодежь, студенты или пенсионеры. Если Вы или один из членов Вашей группы принадлежит к одной из этих категорий, Вы выберите соответствующий вариант плюс к "нормальному тарифу". Пожалуйста, обратите внимание, что в настоящий момент в одной брони нет возможности резервировать и нормальный тариф и тариф со скидкой (например, 2 взрослых и 1 молодежный). Можно выбрать только один тариф в одной брони для всех путешествующих.

- Нормальный тариф (лица старше 12 лет)
- Молодежь (с 12 до ок. 24/25 лет)
- Студенты (с 12 до ок. 27 лет, требуется студенческий билет)
- Пенсионеры (от ок. 60 до 65 лет)
- Этнический (Как правило, требуется гражданство страны прибытия)

[Далее>>](#)

ИRes GmbH 1997 - 2004

Валюта: USD      Версия: 3.571  
Пользователь: не зарегистрирован      Сервер: Res02





# Powerfull Backoffice Managent

## Kundenkenndaten

Kundennummer:  Agenturtyp:

Agenturname:

Kontaktperson:  Inhaber:

## Adresse

Straße / Postfach:

Adreßzusatz 1:

Adreßzusatz 2:

Plz / Ort:

LKZ / Land:   Bundesland:

Telefonnummer:  Faxnummer:

E-Mail-Adresse:  Homepage:

## Öffnungszeiten:

Ausgabe:

Position:

Geöffnet: von  bis

Anwenden für folgende Tage:

Montag	<input checked="" type="checkbox"/>	Dienstag	<input checked="" type="checkbox"/>	Mittwoch	<input checked="" type="checkbox"/>	Donnerstag	<input checked="" type="checkbox"/>
Freitag	<input checked="" type="checkbox"/>	Samstag	<input type="checkbox"/>	Sonntag	<input type="checkbox"/>		

Pausen:

Mittag  von  bis  Nachmittag  von  bis

Neue Öffnungszeiten

Öffn.-zeit löschen

Datensatz:  von 2

Ändern zulassen

Reservierungssysteme

	Pos	Hostsystem	Verwendung	PCC	Queue	Art der Queue-Plazierung	BPCC	BQu	[
▶	1	SABRE VPN	Produktion	LK7A	299	SABRE: Branch Access	N3SA	70	
*									

< [Progress Bar] >

Alle Reservierungssystemeinträge löschen

Vorgaben: SABRE

Selektierten Eintrag löschen

Gewählte Vorgabe einfügen

Fluggesellschaften

Zulässige: \* Ausgeschlossene: M4;EA;K8;N6;HF;TV;DY;C9

Optionsbuchung

Optionsbuchung zulassen: Ja Option endet nach 48 Stunden

Handhabung der Option nach Ablauf: Option wird zur Festbuchung

Automatische Stornierung [ ] Stunden nach Ablauf der Option

Buchungsabschluss und Handling

Minimale Anzahl an Werktagen zwischen Buchung und Abflug (Montag bis Freitag): 2

Buchungsabschluß: Standard - Buchung wird im Reservierungssystem erstellt

Buchungsüberprüfung

Regel: BeforeDeparture:9-1 Stornoemail an Endkunden? Nein

Emailadresse für das Ergebnis der Überprüfung: [ ]

Bankverbindung für den Endkunden:

Name der Bank:       Kontoinhaber:   
 Konto-Nummer:       Bankleitzahl:

Von der Agentur unterstützte Versandarten:

Po#	Versandart	Optionen	Aufschlag	Währ.
▶ 1	NormalMail	TRAVELDATE>10d	2,50	EUR
2	Pick up Good	TRAVELDATE<=10d		
3	Express		13,00	EUR
4	Express International		35,00	EUR
5	UPS		13,00	EUR
6	Ticket on Departure		15,00	EUR

Von der Agentur unterstützte Zahlungsarten:

Po#	Zahlungsart	Optionen	Zuschlag	Währ.
▶ 1	Creditcard IATA			
2	Bill (Bank Transfer)	!IATA;!TRAVELDATE<5d;!ISSUEDA		
3	Bill (Bank Transfer International)	!IATA;!TRAVELDATE<10d;!ISSUEDA		
4	Creditcard			
*				



Stammdaten
  Abrechnung
  Verträge
  Kundenoptionen
  Sonstiges
  Memo
  AGB
  History

## Modullaufzeit:

Ist aktiv?  Implementierungsdatum: **01.07.2000** Automatische Aktivierung zum Startdatum?

Startdatum: **30.06.2000** Ablaufdatum:  Automatische Deaktivierung zum Endedatum?

Datensatzerstellung angefordert von: **Günther Insam**

## Vertragsdaten:

Vertrag?  Vertragsbeginn: **01.06.2001** Laufzeit: **6M** Kündigungsfrist: **6W-Q**

Kündigung?  Kündigungsdatum: **22.06.2001** Vertragsende: **30.11.2001**

Berechnung an andere Agentur?  Agentur-ID:  Agenturtabelle:

Abrechnungsfirma: **>> Keine Berechnung <<**

Anmerkung zum Vertrag:

Vertragsgebühren:

	Pos	Aktiv	Beginn	Gebühr	Wäh	Perio	Peric	Ende	Notiz	Quelle
▶	1	<input checked="" type="checkbox"/>	01.06.2001	35,00	EUR	<input checked="" type="checkbox"/>	1M		easyRes	EASY
	2	<input checked="" type="checkbox"/>	24.01.2000	0,00	EUR	<input checked="" type="checkbox"/>	1M		SabreNet Plattf.	
*		<input type="checkbox"/>				<input type="checkbox"/>				

## Enthaltene Module:

	ModuleID	Modultyp	Agenturnummer:	Admin Username:	Admin Pwd:	
▶	1	EasyRes				<input type="button" value="Flach"/>
	1	WebCreator				<input type="button" value="Hinzufügen"/>
	33	Top Flugangebote				<input type="button" value="Bearbeiten"/>
						<input type="button" value="Löschen"/>

Datensatz:   1

Ändern zulassen

Datensatz:   2

	Bearbeiter	Zeitpunkt	Aktion	Table	IDFieldName
▶	RES\solde.Lutz	03.03.2004 15:20:20	UPDATE	ModuleFlightResSy:	ModuleFlightResSysl
+	RES\solde.Lutz	03.03.2004 11:13:55	UPDATE	ModuleFlight	ModuleID
+	RES\Josef.Wagner	27.02.2004 12:01:02	UPDATE	ModuleFlightFare	ModuleFlightFareID
+	RES\Stefan.Eiselt	23.02.2004 13:20:07	UPDATE	ModuleFlightFare	ModuleFlightFareID
+	RES\Stefan.Eiselt	23.02.2004 13:20:01	UPDATE	ModuleFlightFare	ModuleFlightFareID
+	RES\Josef.Wagner	17.02.2004 18:51:12	UPDATE	ModuleFlightFare	ModuleFlightFareID
+	RES\Josef.Wagner	17.02.2004 18:51:11	UPDATE	ModuleFlightFare	ModuleFlightFareID
+	RES\Stefan.Eiselt	17.02.2004 16:52:57	UPDATE	ModuleFlightFare	ModuleFlightFareID
+	RES\Stefan.Eiselt	17.02.2004 16:52:53	UPDATE	ModuleFlightFare	ModuleFlightFareID
+	RES\Stefan.Eiselt	17.02.2004 16:52:53	UPDATE	ModuleFlightFare	ModuleFlightFareID
+	RES\Stefan.Eiselt	17.02.2004 16:48:32	UPDATE	ModuleFlightFare	ModuleFlightFareID
+	RES\Andreas.Scherer	19.01.2004 12:05:36	UPDATE	ModuleFlight	ModuleID
+	RES\Andreas.Scherer	19.01.2004 11:33:58	UPDATE	ModuleFlight	ModuleID
+	RES\solde.Lutz	16.01.2004 16:30:55	UPDATE	ModuleFlightFare	ModuleFlightFareID
+	RES\Josef.Wagner	11.12.2003 12:46:06	UPDATE	ModuleFlight	ModuleID
+	RES\Josef.Wagner	11.12.2003 12:37:08	UPDATE	ModuleFlight	ModuleID
+	RES\Josef.Wagner	11.12.2003 12:34:37	UPDATE	ModuleFlight	ModuleID
+	RES\Andreas.Scherer	11.12.2003 11:52:04	UPDATE	ModuleFlight	ModuleID
+	RES\Andreas.Scherer	11.12.2003 11:52:02	UPDATE	ModuleFlight	ModuleID
+	RES\Stefan.Eiselt	09.12.2003 17:35:34	UPDATE	ModuleFlight	ModuleID
+	RES\Stefan.Eiselt	09.12.2003 17:28:22	UPDATE	ModuleFlight	ModuleID
+	RES\Stefan.Eiselt	09.12.2003 17:18:29	UPDATE	ModuleFlight	ModuleID
+	RES\Andreas.Scherer	03.12.2003 13:22:52	UPDATE	ModuleFlight	ModuleID
+	RES\Andreas.Scherer	03.12.2003 13:04:11	UPDATE	ModuleFlight	ModuleID
+	RES\Andreas.Scherer	03.12.2003 13:03:58	UPDATE	ModuleFlight	ModuleID

Datensatz: 1 von 77

Datensatzkennung (Debug): 

Schließen

Datensatz: 1 von 1 (Gefiltert)

Standardsprache und -währung der Agentur:

Währung:  Sprache:   
 SubsetID des Kunden:

Hostnamen:

Host-Name	Bevorzugtes Modul
<input type="checkbox"/> ires.at	
<input type="checkbox"/> ires.ch	
<input type="checkbox"/> travelclub.res.de	EasyRes
<input type="checkbox"/> travelclubres.prosieben-club.	EasyRes

Datensatz:       von 4

Zugangsdaten für die Webadministration (Hauptzugang)

Anmelde\_name:  Passwort:   
 PinNummer:  Reset Interval:   
 Anzahl ungültige Eingaben:  Zeitpunkt der letzten ungültige Eingabe:

Zugangsdaten für die Webadministration (Zusätzliche Mitarbeiter)

	Vorname	Nachname	Username	Passwort	Admin	Pool	EasyRes	SP Sub	SP edt.	Sprachen
<input type="checkbox"/>	Michael	Seeberger	test	xxxx	<input type="checkbox"/>	<input type="checkbox"/>	<input type="checkbox"/>	<input checked="" type="checkbox"/>	<input type="checkbox"/>	
<input checked="" type="checkbox"/>					<input type="checkbox"/>	<input type="checkbox"/>	<input type="checkbox"/>	<input type="checkbox"/>	<input type="checkbox"/>	

Datensatz:       von 1

## Seitenaufbau

Logo am Seitenanfang:

Einträge im Pulldownmenü:

Art der Wartemeldung:  ▼

## Werbung

Werbung darstellen:  ▼ Werbungssystem:  ▼

Position der Werbung:  ▼

## Kabinenklasse

Kabinenklasse (Vorgabe):  ▼

Kabinenklasse-Optionen:  Eco  Business  First

Bei kombinierten Vorgabewerten sollte keine Option gewählt werden, da sonst bei der Abfrage nicht kombiniert wird.

## Anmeldung

erforderlich bei  anderen Ursprungsländer als unten angegeben  Anfragen mit nur IATA-Fares

Ursprungsländer ohne Login:  Pagemode mit Login:  ▼

## Reiseversicherung

Darstellen?  ▼ Primäre Agentnr:  Sekundäre Agentnr:

## Sonstiges

Pflichtfelder Adressdaten

Option "Newsletter" darstellen  ▼ Tarifseite überspringen (=Powershopper only)  ▼

Abfrageparameter:

Eintrag aktiv?  Datenbank: **AERNET** Agenturnummer: **499020**

Abfrageparameter:

Reihenfolge des Tarifs bei der Tarifabfrage: **1** Abfragelevel (max. Tarife): **-1**

Citycode für die Steuerberechnung:  Ursprungsländer: **DE**

AttributID für die Datenbank (AKULINK):  Negofares darstellen: **Nein**

Buchungsformat (Remarks): **AER IBE Remarks**

AER ClosedUserGroups (CUC): **ALL;ONA**

Achtung: Kein Wert bei CUG bedeutet "ALLE TARIFE". D.h. bei AER immer mindestens "ALL" eintragen

Kalkulation:

Brutto/Netto-Schalter: **Netto/Netto** Währung der Kalkulation: **EUR**

Netto/Netto-Zuschlag (AddToFare): **10,00** Minimaler Zuschlag (MinMarkup): **15,00**

Prozentualler Zuschlag (Percentage): **0,00** Dezimalstellen (DecPlaces): **0**

Steuerzuschlag (TaxAddOn): **3,00**

Benutzerdefinierte Kalkulation:

```
FROM=00000000.00;TO=00000099.99;METHODE=ADD;CALC=25;CURR=EUR
FROM=00000100.00;TO=00000149.99;METHODE=ADD;CALC=28;CURR=EUR
FROM=00000150.00;TO=00000199.99;METHODE=ADD;CALC=31;CURR=EUR
FROM=00000200.00;TO=00000249.99;METHODE=ADD;CALC=34;CURR=EUR
```

Datensatz hinzufügen | Datensatz löschen

Datensatz:       von 4

Datensatzkennung (Debug):

Schließen

Datensatz:       von 1 (Gefiltert)



# Layout Manager

# Pool Access data

Adresse <http://usa.ires-pool.de/>

Menu Index:

[STARTSEITE](#) | [FIRMENDATEN](#) | [EASY RES](#) | [HOMEPAGE](#) | [?](#)

[ADDRESS DATA](#) | [BANK ACCOUNT DATA](#) | [ACCESSDATA](#) | [OPENING HOURS](#) | [CUSTOMER PAYMENT](#) | [SHIPMENT](#) | [TERMS AND CONDITIONS](#) | [SETTINGS](#)

### COMPANY PROFILE IRES-POOL: CHANGING YOUR ACCESS INFORMATION

To change the access information to the IRES-Pool for **Worldspan Demo**, please change the desired fields in the following form and save the changes to update your access information.

Please note this information carefully! The next time you try to access this site you will have to log in with the new access information, if you change it now.

Your ID for the IRES-Pool / IRES

Your log in name IRES-Pool / IRES

Your old (current) password for IRES-Pool / IRES

Your new password for IRES-Pool / IRES

Please repeat your new password

Please check if the information you have entered is correct and save these changes.

[ADDRESS DATA](#) | [BANK ACCOUNT DATA](#) | [ACCESSDATA](#) | [OPENING HOURS](#) | [CUSTOMER PAYMENT](#) | [SHIPMENT](#) | [TERMS AND CONDITIONS](#) | [SETTINGS](#)

Remote-Login: 84.128.36.153 | IRES-ID: 1227 | Sprachwahl: deutsch | 4 User online | Version 1.114 Sec01

# Pool Start Page

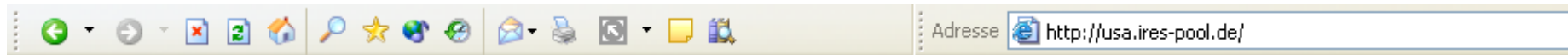

Menu Index:

STARTSEITE

FIRMENDATEN

EASY RES

HOMEPAGE

?

## STARTPAGE IRES-POOL

Your IRES Account is active

Your Homepage-URL after installation:  
<http://ires-pool.de/hp/1227>

You did not select a layout yet.

You do not have a homepage yet

You did not yet create your own pages

[167 Webpage requests](#) this Pools under the ID  
1227

You are using a current browser, which is suited for these pages: "Mozilla/4.0 (compatible; MSIE 6.0; Windows NT 5.1; .NET CLR 1.1.4322; .NET CLR 1.0.3705)". Java and JavaScript must be activated in your browser to view these pages!

Notice:

1. This page does not use cookies. No cookies will be written or read from your computer!
2. If you press the "Reload"-button of your browser you will be directed back to the startpage of the IRES-Pool.

## Only if you want to set up your homepage with us:

You don't have a homepage in the pool yet! Read the "Step by step" introduction, click [here please](#). Proceed as follows, if you need a homepage:

1. Click on the index card LAYOUT POOL
2. Click on the LAYOUT-SELECTION
3. Select your layout by pressing one of the buttons
4. Press ACCEPT, to create your homepage

Follow the text and links there, to make further changes to your pages.

**If you do not need a homepage, you can directly go to the settings by clicking on COMPANY PROFILE and EASY RES.**

If you have questions or problems concerning this system, please click on the help index card ( ? ) at the right corner of the index cards. You will find an easily understandable online help area there.

You can also reach our IRES-Pool Hotline by calling 089-54916590 or you may send an email to the [IRES-Pool support](#) if you are stuck.

## Special hint:

The pages are best viewed on Microsoft Internet Explorer (Version 5 or newer) or Netscape (Version 6 or newer), because these browsers can display

# Pool Company Info



Menu Index:

[STARTSEITE](#)

[FIRMENDATEN](#)

[EASY RES](#)

[HOMEPAGE](#)

[?](#)

[ADDRESS DATA](#) | [BANK ACCOUNT DATA](#) | [ACCESS DATA](#) | [OPENING HOURS](#) | [CUSTOMER PAYMENT](#) | [SHIPMENT](#) | [TERMS AND CONDITIONS](#) | [SETTINGS](#)

## COMPANY PROFILE IRES-POOL

You may update your own user profile here. This will hardly ever be necessary. If you have a new telephone number or a different address you should change these settings here.

To do so, please select the desired area in the menu above. Please remember to always save any changes you make [UPDATE SETTINGS]. Only then will the changes be saved with IRES and the the IRES-Pool.

If you have questions or problems concerning this system, please click on the "help" tab (  ) located to the far right, where you will find context sensitive tips.

You may also call our IRES-Pool Hotline ( 089-54916590 ) or send an email [to the support team](#) if you are stuck.

[ADDRESS DATA](#) | [BANK ACCOUNT DATA](#) | [ACCESS DATA](#) | [OPENING HOURS](#) | [CUSTOMER PAYMENT](#) | [SHIPMENT](#) | [TERMS AND CONDITIONS](#) | [SETTINGS](#)

# Pool CRS def.

The screenshot shows a web browser window with the address bar containing `http://usa.ires-pool.de/`. The website header features the IRES Pool logo and a 'Menu Index' dropdown menu with a 'GO' button. The navigation bar includes tabs for 'STARTSEITE', 'FIRMENDATEN', 'EASY RES', and 'HOMEPAGE'. A secondary navigation bar contains links for 'ADDRESSDATA', 'BANK ACCOUNT DATA', 'ACCESS DATA', 'OPENING HOURS', 'CUSTOMER PAYMENT', 'SHIPMENT', 'TERMS AND CONDITIONS', and 'SETTINGS'. The main content area is titled 'COMPAN TERMS AND CONDITIONS POL: MODIFICATION OF ADDRESS'. It contains a paragraph of instructions: 'To change the permanent data for Worldspan Demo in IRES and in the IRES-Pool, change the desired field below and then click Update Settings to save your changes. Please insert the telephone- and faxnumber in the international format if you do not reside in Germany. (e.g. +43 xxxx)!' Below this is a form with the following fields: 'Company name' (Worldspan Demo), 'Owner' (Günther Insam), 'Person of contact' (Günther Insam), 'Address' (Rottmannstraße 11, 80333 München, Deutschland), '(Federal) State' (Bayern), 'Telephone number' (01805 54916516), 'Telephone number' (01805 358432), 'E-mail address' (info@ires.net), and 'Homepage' (http://www.ires.net). A note below the form says 'Your domain with IRES'. At the bottom of the form is an 'Update Settings' button. The footer contains the same navigation links as the secondary bar and a status bar with the text: 'Remote-Login: 84.128.36.153 | IRES-ID: 1227 | Sprachwahl: deutsch | 5 User online | Version 1.114 Sec01'.

Menu Index:

STARTSEITE | FIRMENDATEN | EASY RES | HOMEPAGE | ?

[ADDRESSDATA](#) | [BANK ACCOUNT DATA](#) | [ACCESS DATA](#) | [OPENING HOURS](#) | [CUSTOMER PAYMENT](#) | [SHIPMENT](#) | [TERMS AND CONDITIONS](#) | [SETTINGS](#)

COMPAN [TERMS AND CONDITIONS](#) POL: MODIFICATION OF ADDRESS

To change the permanent data for **Worldspan Demo** in IRES and in the IRES-Pool, change the desired field below and then click Update Settings to save your changes. **Please insert the telephone- and faxnumber in the international format if you do not reside in Germany. (e.g. +43 xxxx)!**

Company name	Worldspan Demo		
Owner	<input type="text" value="Günther Insam"/>	Person of contact	<input type="text" value="Günther Insam"/>
Address	Rottmannstraße 11 80333 München Deutschland	(Federal) State	Bayern
Telephone number	<input type="text" value="01805 54916516"/>	Telephone number	<input type="text" value="01805 358432"/>
E-mail address	<input type="text" value="info@ires.net"/>	Homepage	<input type="text" value="http://www.ires.net"/>

Your domain with IRES

Check if your data is correct and than press the Update Settings button. If the data that you are not allowed to change is incorrect, please send [an email to us](#) or oder call IRES GmbH under 089-54916570. Thank You!

[ADDRESSDATA](#) | [BANK ACCOUNT DATA](#) | [ACCESS DATA](#) | [OPENING HOURS](#) | [CUSTOMER PAYMENT](#) | [SHIPMENT](#) | [TERMS AND CONDITIONS](#) | [SETTINGS](#)

Remote-Login: 84.128.36.153 | IRES-ID: 1227 | Sprachwahl: deutsch | 5 User online | Version 1.114 Sec01

# Pool Query Box

The screenshot shows a web browser window displaying the IRES Pool website. The address bar shows the URL: [http://usa.ires-pool.de/easyres.html?RB\\_ID=1227&action=spec](http://usa.ires-pool.de/easyres.html?RB_ID=1227&action=spec). The page title is "IRES Pool". The navigation menu includes: STARTSEITE, FIRMENDATEN, EASY RES, and HOMEPAGE. The main content area is titled "EASY RES: CONFIGURATION 'EasyRes BoX'".

**EASY RES: CONFIGURATION "EasyRes BoX"**  
The Sourcecode for the **EasyRes BoX** works as interface to the EasyRes system. This code allows a flightquery (API-mode 1), where the visitor of your homepage can configure the necessary settings very quickly.

Using this query, you dont have to do the time-consuming configuration of the different EasyRes query-options, but with the ease of one click in the BoX-window, you are shown the availabilities of the EasyRes system.

If you have questions or problems concerning this system, please click on the help index card ( ? ) at the right corner of the index cards. You will find an easily understandable online-help here.

**You can also call our EASY RES Hotline (not the IRES Pool Hotline!) by this number 089-54916570, or send an email to an EASY RES employee if you are stuck.**

You can download the complete [descriptor of our API](#) for programmers here.

**Configuration of your personal codes for the EasyRes BoX (for programmers only)**  
Please fill out all fields below, and then click on the "Generate Code for EasyRes BoX"-button to receive the code, than may than be copied directly into your webpage.

Specify the email address where you would like the code to be sent to:   
(leave empty for testing!)  
Your IRes ID:   
Your IRes hostname:

Display for date of flight:

Example 1: Date of flight:   till    
Example 2: Date of flight:   Returnflight after    
(the date will be automatically determined for the output.)

Country of departure:  city:   
 or city:  (all important departure airports in the EU)

Destination:

Passanger:   
Example of a combined view:   
Example of a single view: Adults:  Children:  Infants:

Color: Table-border on the outside:

# Pool Bank Account

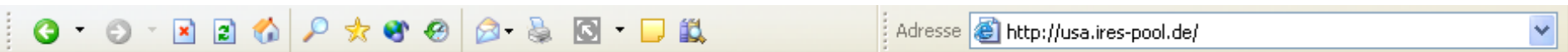

Menu Index:

- STARTSEITE
- FIRMENDATEN
- EASY RES
- HOMEPAGE
- ?

[ADDRESS DATA](#) | [BANK ACCOUNT DATA](#) | [ACCESS DATA](#) | [OPENING HOURS](#) | [CUSTOMER PAYMENT](#) | [SHIPMENT](#) | [TERMS AND CONDITIONS](#) | [SETTINGS](#)

## COMPANY PROFILE IRES-POOL: MODIFICATION OF YOUR ACCOUNT DATA

To change the bank account for your credit entries at **Worldspan Demo** in IRES and IRES-Pool change the desired fields on this page and then save your settings.

The following items refer to the bank account which should receive payments for reservations made on the system.

Name of the bank	<input type="text"/>
Bank routing number	<input type="text"/>
Bank account number	<input type="text"/>
Account holder	<input type="text"/>

Check the entries and then click "Update information", to update these information.

[ADDRESS DATA](#) | [BANK ACCOUNT DATA](#) | [ACCESS DATA](#) | [OPENING HOURS](#) | [CUSTOMER PAYMENT](#) | [SHIPMENT](#) | [TERMS AND CONDITIONS](#) | [SETTINGS](#)

# Pool Opening Hours



Menu Index:

- STARTSEITE
- FIRMENDATEN
- EASY RES
- HOMEPAGE
- ?

[ADDRESS DATA](#) | [BANK ACCOUNT DATA](#) | [ACCESS DATA](#) | [OPENING HOURS](#) | [CUSTOMER PAYMENT](#) | [SHIPMENT](#) | [TERMS AND CONDITIONS](#) | [SETTINGS](#)

## COMPANY PROFILE IRES-POOL: OPENING HOURS

Here you may change the settings of your opening hours yourself. After you have changed your settings please click to update the settings on the update settings button.

Please enter the times using the following format: hh:mm (e.g. 09:30)!

### BLOCK 1. Your opening hours during working day

- |   |   |
|---|---|
| <input checked="" type="checkbox"/> Monday    | Fixed opening hours:  |
| <input checked="" type="checkbox"/> Tuesday   | start <input type="text" value="09:00"/> o'clock end <input type="text" value="18:00"/> o'clock |
| <input checked="" type="checkbox"/> Wednesday | Lunch break times:  |
| <input checked="" type="checkbox"/> Thursday  | start <input type="text" value="00:00"/> o'clock end <input type="text" value="00:00"/> o'clock |
| <input checked="" type="checkbox"/> Friday    | Afternoon break times:  |
| <input type="checkbox"/> Saturday             | start <input type="text"/> o'clock end <input type="text"/> o'clock                             |
| <input type="checkbox"/> Sunday               |   |

### BLOCK 2. Further opening hours on non working days (e. g. saturdays)

- |                                    |   |
|------------------------------------|---|
| <input type="checkbox"/> Monday    | Fixed opening hours:  |
| <input type="checkbox"/> Tuesday   | start <input type="text"/> o'clock end <input type="text"/> o'clock |
| <input type="checkbox"/> Wednesday | Lunch break times:  |
| <input type="checkbox"/> Thursday  | from <input type="text"/> o'clock to <input type="text"/> o'clock   |
| <input type="checkbox"/> Friday    | Zeiten Nachmittagsruhe:   |
| <input type="checkbox"/> Saturday  |   |

# Pool Payment Setup

Internet Explorer browser window showing the IRES Pool website. The address bar contains: [http://usa.ires-pool.de/firmendaten.html?RB\\_ID=1227&action=](http://usa.ires-pool.de/firmendaten.html?RB_ID=1227&action=)

**IRES Pool**

Menu Index: [v] GO

STARTSEITE | **FIRMENDATEN** | EASY RES | ...

[ADDRESS DATA](#) | [BANK ACCOUNT DATA](#) | [ACCESS DATA](#) | [OPENING HO](#) | [TERMS AND](#)

[CONDITIONS](#) | [SETTINGS](#)

### COMPANY PROFILE IRES-POOL: CUSTOMER PAYMENT

In the submenu COMPANY PROFILE you may correct or change the payment for tickets, documents etc. to your customer or [NEW RECORD], after you have changed your information.

Make this way of payment newly available

**Creditcard**

- Debit
- Electronic CityBank Debit
- ICounterDirectDebit
- Blitzüberweisung (Swift)

New Record

Change of form of payment  
**Bill (Bank Transfer)**

**Output position:** 1 (available)

**Surcharge:** [input field]

**Default surcharge:** 0.00 EUR  
(will only be used if the field "Default surcharge:" is empty)

**Additional output filter:** [input field]

- Change form of payment
- Delete form of payment

UPDATE SETTINGS

Dropdown menu (Currency):

- Argentinsische Pesos (ARS)
- Australischer Dollar (AUD)
- Bahama-Dollar (BSD)
- Bahrain-Dinar (BHD)
- Baht (THB)
- Barbados-Dollar (BBD)
- Belgischer Franc (BEF)
- Belize-Dollar (BZD)
- Bermuda-Dollars (BMD)
- Bolívar (VEB)
- Brunei-Dollar (BND)**
- CFA-Franc (XAF)
- Chilenische Pesos (CLP)
- Colón (SVC)
- Dalas (GMD)
- Dänische Krone (DKK)
- Dirham (AED)
- Dirham (MAD)
- Dominikanischer Peso (DOP)
- Drachme (GRD)
- Dschibuti-Franc (DJF)
- Emalangi (SZL)
- Estnische Krone (EEK)
- Euro (EUR)
- Falkland-Pfund (FKP)
- Fiji Dollar (FJD)
- Finnische Mark (FIM)
- Forint (HUF)
- Französischer Franc (FRF)
- Gibraltar-Pfund (GIP)
- Ägyptisches Pfund (EGP)

# Pool IBE Design



Menu Index:

STARTSEITE

FIRMENDATEN

EASY RES

HOME PAGE

?

[BASIC SETTINGS](#) | [LAYOUT](#) | [HTML](#) | [CHARGE SETTINGS](#) | [RESERVATION SYSTEMS](#) | [ADDITIONAL SETTINGS](#)  
[INTERGRATION INTO THE HOMEPAGE](#) | [START EASYRES CHECK HOMEPAGE FOR LAYOUT/HTML](#)

## EASY RES RESERVATIONSYSTEM: HTML

On this page you may choose between different predefined HTML-designs or create your own costum HTML-design. This requires a good knowledge of HTML and StyleSheets. If you are not shure what you are doing, just leave these settings and go back.

### Choose from these HTML-designs:

Design "Graue Maus" (Preset is not editable) ACTIVE

### What do you want to do?

- Activate HTML-design
- Edit HTML-design
- Delete HTML-design
- Create new HTML-Design
- Create a new HTML-design (as copy of existig)

### HTML-designs available for activation:

The screenshot shows a web browser window with the URL 'http://usa.ires-pool.de/easyres.html?RB\_ID=1227&action=html'. The page title is 'Unterlage' and the browser address bar shows 'http://usa.ires-pool.de/easyres.html?RB\_ID=1227&action=html'. The page content includes a navigation menu with 'Startseite', 'Firmendaten', 'Easy Res', and 'Homepage'. Below the menu, there are several sections: 'BASIC SETTINGS', 'LAYOUT', 'HTML', 'CHARGE SETTINGS', 'RESERVATION SYSTEMS', and 'ADDITIONAL SETTINGS'. The 'HTML' section is active, and the 'Design "Graue Maus" (Preset is not editable) ACTIVE' is selected. The page also features a 'What do you want to do?' section with radio buttons for 'Activate HTML-design', 'Edit HTML-design', 'Delete HTML-design', 'Create new HTML-Design', and 'Create a new HTML-design (as copy of existig)'. A 'Start' button is located below the radio buttons. At the bottom of the page, there is a footer with the IRES logo and contact information.

The screenshot shows a web browser window with the URL 'http://usa.ires-pool.de/easyres.html?RB\_ID=1227&action=html'. The page title is 'Unterlage' and the browser address bar shows 'http://usa.ires-pool.de/easyres.html?RB\_ID=1227&action=html'. The page content includes a navigation menu with 'Startseite', 'Firmendaten', 'Easy Res', and 'Homepage'. Below the menu, there are several sections: 'BASIC SETTINGS', 'LAYOUT', 'HTML', 'CHARGE SETTINGS', 'RESERVATION SYSTEMS', and 'ADDITIONAL SETTINGS'. The 'HTML' section is active, and the 'Design "Graue Maus" (Preset is not editable) ACTIVE' is selected. The page also features a 'What do you want to do?' section with radio buttons for 'Activate HTML-design', 'Edit HTML-design', 'Delete HTML-design', 'Create new HTML-Design', and 'Create a new HTML-design (as copy of existig)'. A 'Start' button is located below the radio buttons. At the bottom of the page, there is a footer with the IRES logo and contact information.



Selection of several  
Consolidators databases own  
calculations mixable with IATA and  
net and nego or low cost fares

# Consolidator Selection

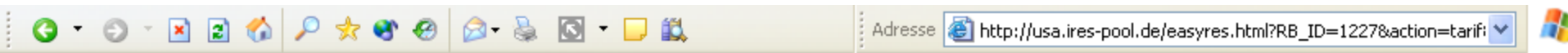

Menu Index:

[STARTSEITE](#) | [FIRMENDATEN](#) | [EASY RES](#) | [HOMEPAGE](#) | [?](#)

[BASIC SETTINGS](#) | [LAYOUT](#) | [HTML](#) | [CHARGE SETTINGS](#) | [RESERVATION SYSTEMS](#) | [ADDITIONAL SETTINGS](#)  
[INTERGRATION INTO THE HOMEPAGE](#) | [START EASYRES](#)

## EASY RES RESERVATIONSYSTEM: FARE SETTINGS

Please choose a consolidator and save this page, to update your data.

EASYFLIGHTS   
EASYFLIGHTS  
AERNET  
MCF  
ABCMil  
IATADE

[BASIC SETTINGS](#) | [LAYOUT](#) | [HTML](#) | [CHARGE SETTINGS](#) | [RESERVATION SYSTEMS](#) | [ADDITIONAL SETTINGS](#)  
[INTERGRATION INTO THE HOMEPAGE](#) | [START EASYRES](#)

# API Download

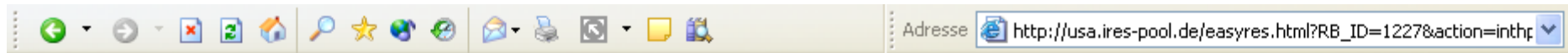

Menu Index:

STARTSEITE

FIRMENDATEN

EASY RES

HOMEPAGE

?

[BASIC SETTINGS](#) | [LAYOUT](#) | [HTML](#) | [CHARGE SETTINGS](#) | [RESERVATION SYSTEMS](#) | [ADDITIONAL SETTINGS](#)

INTERGRATION INTO THE HOMEPAGE | [START EASYRES](#)

[INTEGRATION INTO THE HOMEPAGE](#) ▶ [EASYRES EXPRESS](#) | [EASYRES BOX](#)

## EASY RES: INTEGRATION INTO THE HOMEPAGE

On these pages you will find valuable tools and hints to integrate codes for the execution of EasyRes (Interface) into your homepage.

You will find these tools in the menubar, just below the the index cards. Click on the desired option to edit the settings.

You can download the complete [description of our API](#) here. This document is aimed for programmers and can be studied peacefully offline after the download (PDF-reader required). It describes all possibilities of the interface to our EasyRes system.

If you have questions or problems concerning this system, please click on the help index card (  ) at the right corner of the index cards. You will find an easily understandable online-help here.

**You can also call our EASY RES Hotline (not the IRES Pool Hotline!) by this number 089-54916570, or send an email to an [EASY RES employee](#) if you are stuck.**

[BASIC SETTINGS](#) | [LAYOUT](#) | [HTML](#) | [CHARGE SETTINGS](#) | [RESERVATION SYSTEMS](#) | [ADDITIONAL SETTINGS](#)

INTERGRATION INTO THE HOMEPAGE | [START EASYRES](#)

[INTEGRATION INTO THE HOMEPAGE](#) ▶ [EASYRES EXPRESS](#) | [EASYRES BOX](#)

# Express Box Creator



Menu Index:

STARTSEITE | FIRMENDATEN | **EASY RES** | HOMEPAGE | ?

[BASIC SETTINGS](#) | [LAYOUT](#) | [HTML](#) | [CHARGE SETTINGS](#) | [RESERVATION SYSTEMS](#) | [ADDITIONAL SETTINGS](#)

[INTERGRATION INTO THE HOMEPAGE](#) | [START EASYRES](#)

[INTEGRATION INTO THE HOMEPAGE](#) ▶ [EASYRES EXPRESS](#) | [EASYRES BOX](#)

## EASY RES: CONFIGURATION "EasyRes Express"

The sourcecode for **EasyRes Express** is a code that works as an interface to EasyRes. This code allows a flightquery (API-Mode 1), whereby the visitor of your homepage can enter the required settings very quickly.

Using this express-query you dont have to do the time-consuming configuration of the different EasyRes query-options, but with the ease of one click in the express-window, you are shown the pricelistings of the EasyRes system.

If you have questions or problems concerning this system, please click on the help index card (  ) at the right corner of the index cards. You will find an easily understandable online-help here.

**You can also call our EASY RES Hotline (not the IRES Pool Hotline!) by this number 089-54916570, or send an email to an [EASY RES employee](#) if you are stuck.**

You can download the complete [description of our API](#) for programmers here.

## Configuration of your personal sourcecode for "EasyRes Express" (for programmers only!)

Please fill out every field of this form and then click the "Send Data" button. You will then receive the sourcecode for the insertion into your website. Please note that your provider must support the chosen script-language, because if not the code wont be executable!

Where should we send the sourcecode to?

(leave blank for testing!)

Your IRes ID

Your IRes hostname

Which departure list shall be displayed?

Desired default for the airport of departure

# Query Box Creator

# EasyRes Layout



Adresse [http://usa.ires-pool.de/irespool.html?RB\\_ID=1227&sess=5D270](http://usa.ires-pool.de/irespool.html?RB_ID=1227&sess=5D270)



Menu Index:

STARTSEITE

FIRMENDATEN

EASY RES

HOMEPAGE

?

## LAYOUT

### IRES POOL HOMEPAGE

This is your administration-tool for the IRES-Pool. Here you may change all settings and definitions for your own pool-homepage and the modules.

You will find the sub menus in the first row below the index cards. These are called LAYOUT, WEBPAGES und MODULES. Additionally you will find links to open your homepage and the statistics for your homepage.

In the second row of the menu you options will appear, depending on the submenu you have chosen. Click on one of these to edit these options or click on one of the sub menu links to change to a different sub menu.

If you have questions or problems concerning this system, please click on the help index card (  ) at the right corner of the index cards. You will find an easily understandable online-help here.

**For a "step by step" introduction [please click here.](#)**

You may also call our IRES-Pool Hotline ( 089-54916590 ) or send an email [to the support team](#) if you are stuck.

## LAYOUT

# Technology

- Server Farm
- Loadbalancing
- 2 Climasystems
- USV,s
- Leased line connections to the CRS systems
- VPN / HFP
- Daily database downloads from consolidators
- Fully scalable IP connectivity via Ebone
- (up to 115 MBit/s)



# *IRes System overview*

- The flowchart displays the system process of „EasyRes“
- Several steps are obtaining all necessary clients` - and flight parameter, being the base for any request being directed to Amadeus.  
These parameters are used for the creation of a PNR (passenger name record) - together with results directed from systems requests „fares“, „availability“ & „pricing”

# Computer Center

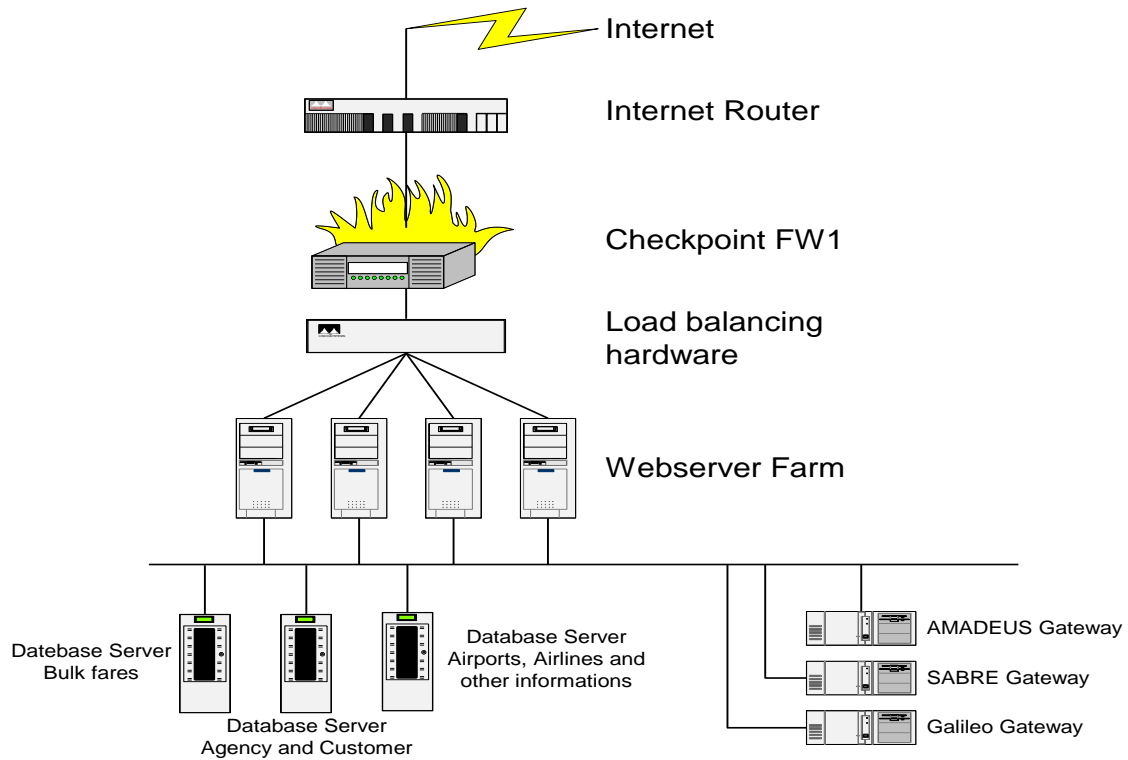

# System Overview

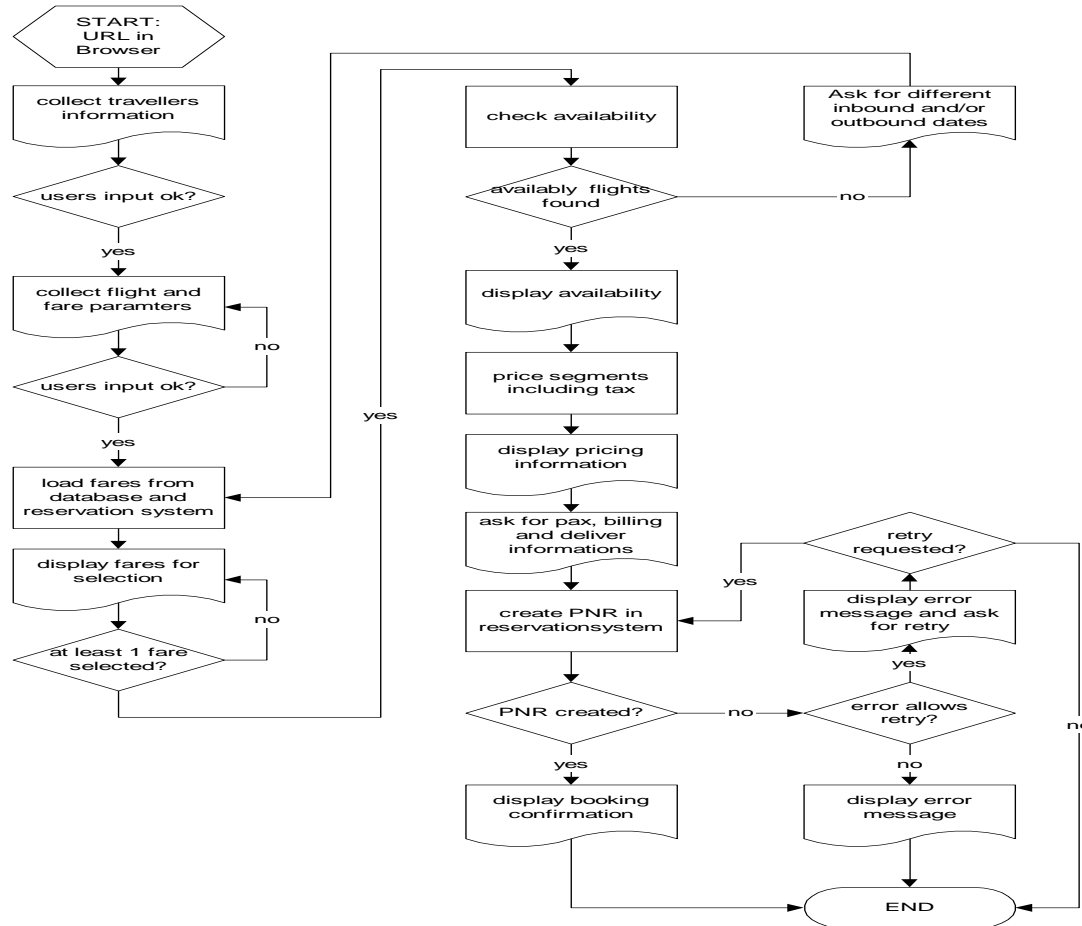

# Process details

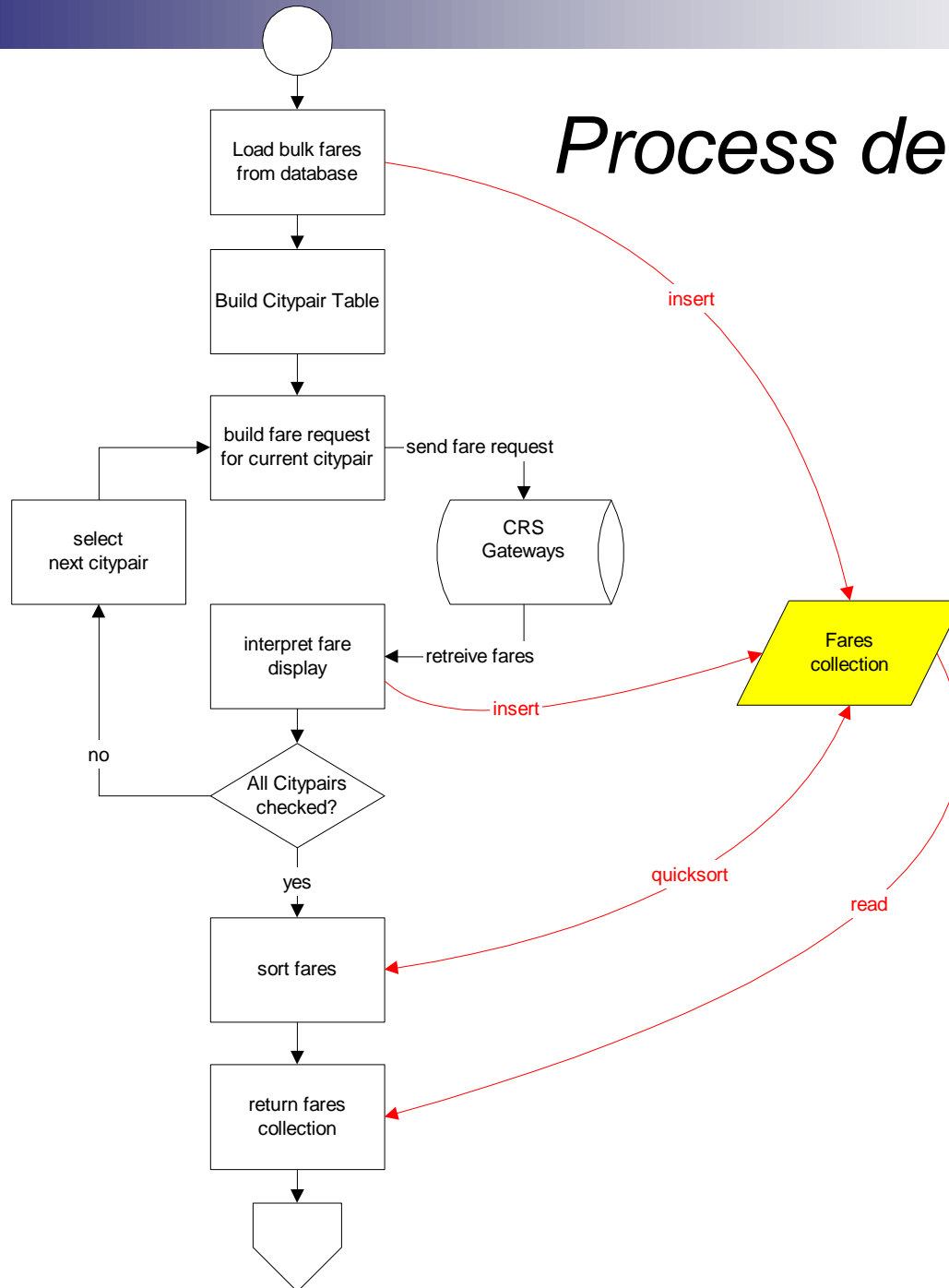

# Availability Check

